

PLUS LG

Multistage Vertical

Stainless steel multistage vertical pumps. Pumping of clean non-loaded fluids, pressurizing system, irrigation, drinking and glycol water, water treatment, food industry, heating and air conditioning, washing system.

Construction features

Pump body	cast iron
Motor bracket	cast iron
Impellers, diffusers	Noryl®
Shell, motor shaft	stainless steel AISI 304
Mechanical seal	ceramic-graphite-EPDM graphite-silicon carbide-EPDM
Intermediate shaft guiding stage bush	ceramic-tungsten carbide
Ambient temperature	max 40 °C
Liquid temperature	+5 ÷ +35 °C
Max operating pressure	14 bar
Pump body gasket	EPDM

Motor

2 poles induction motor	3~ 400/690V - 50Hz P > 4kW
Insulation class	F
Protection degree	IPX5



P 18 L G - 920 / 10 T

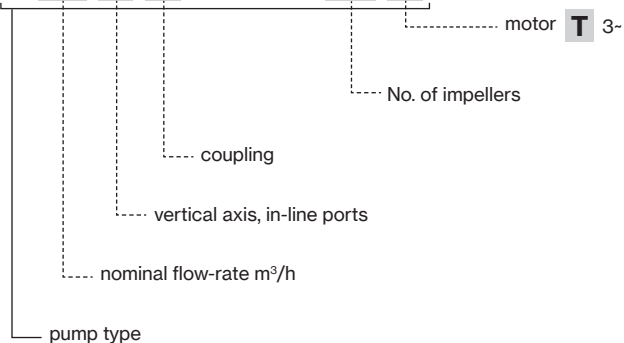

PLUS V/L

TYPE - 50 Hz		P2		P1		CURRENT		Q (m³/h - l/min)						
1-	3-			1-	3-	1- 230V	3- 400V	0	0,6	1,2	1,8	2,4	3,6	4,8
		0	10					20	30	40	60	80		
		HP	kW	kW		A								
P 3...-100/5	P 3...-100/5T	1	0,75	1,1	1	4,8	1,9	52,2	48,9	45,1	40,8	36,0	25,4	14,0
P 3...-120/6	P 3...-120/6T	1,2	0,9	1,2	1,2	5,6	2,6	62,8	58,7	54,5	49,6	43,9	32,1	18,3
P 3...-150/7	P 3...-150/7T	1,5	1,1	1,3	1,2	6,1	3,0	77,1	76,1	73,2	68,4	62,3	46,5	25,7
P 3...-180/8	P 3...-180/8T	2	1,5	1,5	1,4	7,0	3,1	88,1	87,2	83,5	77,6	70,2	51,3	26,0
P 3...-200/9	P 3...-200/9T	2	1,5	1,6	1,5	7,4	3,2	98,8	97,2	93,7	87,3	79,4	60,0	32,2
P 3...-250/10	P 3...-250/10T	2	1,5	1,7	1,7	7,9	3,5	109,3	108,2	103,6	96,3	87,5	65,3	34,5
P 3...-280/11	P 3...-280/11T	2,5	1,85	2,0	1,8	9,4	3,8	120,4	118,7	113,8	106,1	96,4	71,6	38,3
P 3...-300/12	P 3...-300/12T	2,5	1,85	2,1	2,0	9,8	4,0	130,3	128,5	122,9	114,6	103,8	76,6	40,8

TYPE - 50 Hz		P2		P1		CURRENT		Q (m³/h - l/min)							
1-	3-			1-	3-	1- 230V	3- 400V	0	1,8	2,4	3,6	4,8	6	7,2	8,4
		0	30					40	60	80	100	120	140		
		HP	kW	kW		A									
P 5...-120/4	P 5...-120/4T	1,2	0,9	1,13	1,13	5,2	2,5	45,3	41,3	39,6	35,6	30,8	24,9	17,6	6,4
P 5...-150/5	P 5...-150/5T	1,5	1,1	1,4	1,4	6,6	3,1	57,6	55,6	54,2	50,5	45,0	37,0	27,4	
P 5...-180/6	P 5...-180/6T	2	1,5	1,6	1,6	7,4	3,3	69,1	66,5	64,8	60,1	53,2	43,8	32,0	
P 5...-200/7	P 5...-200/7T	2	1,5	1,9	1,8	8,6	3,6	80,6	77,1	75,1	69,6	61,3	50,4	35,8	
P 5...-250/8	P 5...-250/8T	2,5	1,85	2,2	2,1	9,9	4,1	92,0	88,2	85,8	79,2	70,1	57,2	41,1	
P 5...-280/9	P 5...-280/9T	2,5	1,85	2,4	2,3	10,9	4,3	103,3	98,9	96,2	88,8	78,4	64,1	45,3	
P 5...-300/10	P 5...-300/10T	3	2,2	2,7	2,6	12,5	4,9	115,1	110,6	107,6	99,5	87,6	72,1	50,7	
P 5...-350/11	P 5...-350/11T	3,5	2,57	3,0	2,9	13,7	5,3	127,6	122,5	119,4	110,8	98,0	80,8	57,4	
-	P 5...-380/12T	4	3	-	3,2	-	6,0	140,3	135,4	132,1	123,2	109,5	90,1	66,5	

TYPE - 50 Hz		P2		P1		CURRENT		Q (m³/h - l/min)						
1-	3-			1-	3-	1- 230V	3- 400V	0	2,4	3,6	4,8	6	7,2	8,4
		0	40					60	80	100	120	140		
		HP	kW	kW		A								
P 7...-180/4	P 7...-180/4T	2	1,5	1,7	1,6	7,9	3,3	49,6	48,4	46,7	43,8	39,9	34,9	28,9
P 7...-250/5	P 7...-250/5T	2,5	1,85	2,2	2,0	9,9	4,0	63,2	62,1	60,3	56,9	52,1	46,2	39,0
P 7...-300/6	P 7...-300/6T	3	2,2	2,5	2,4	11,5	4,7	76,0	75,1	73,1	69,2	63,6	56,8	48,2
-	P 7...-350/7T	3,5	2,57	-	2,8	-	5,1	89,0	88,0	85,8	81,2	74,5	66,3	56,2
-	P 7...-400/8T	4	3	-	3,1	-	5,9	102,3	101,0	98,2	92,4	84,4	74,6	62,4
-	P 7...-450/9T	4,5	3,37	-	3,6	-	6,5	115,2	114,4	111,4	105,6	97,1	86,3	73,1
-	P 7...-550/10T	5,5	4	-	4,0	-	7,7	128,1	128,0	124,9	118,7	109,4	97,6	83,0

TYPE - 50 Hz		P2		P1		CURRENT		Q (m³/h - l/min)						
1-	3-			1-	3-	1- 230V	3- 400V	0	3,6	4,8	7,2	9,6	12	13,2
		0	60					80	120	160	200	220		
		HP	kW	kW		A								
P 9...-200/4	P 9...-200/4T	2	1,5	1,8	1,7	8,3	3,5	45,8	42,1	40,7	37,3	31,3	23,0	17,9
P 9...-250/5	P 9...-250/5T	2,5	1,85	2,3	2,1	10,4	4,1	56,9	52,2	50,4	46,1	38,8	28,2	22,3
P 9...-300/6	P 9...-300/6T	3	2,2	2,8	2,6	12,8	5,0	69,8	64,5	62,5	57,5	48,8	36,4	29,6
-	P 9...-400/7T	4	3	-	3,0	-	5,8	83,3	77,8	75,7	68,9	58,5	43,6	34,7
-	P 9...-450/8T	4,5	3,37	-	3,5	-	6,4	96,7	90,7	88,2	80,6	69,2	52,2	42,1
-	P 9...-500/9T	4,5	3,37	-	3,9	-	6,9	107,1	99,5	96,4	88,3	75,2	56,4	45,2
-	P 9...-550/10T	5,5	4	-	4,3	-	8,1	119,5	111,6	108,2	99,3	84,6	63,5	51,2

PLUS V/L

TYPE - 50 Hz	P2		P1	CURRENT	Q (m³/h - l/min)									
					3- 400V									
	HP	kW	kW	A	0	6	7,2	9,6	12	14,4	16,8	19,2	21,6	24
3-					0	6	7,2	9,6	12	14,4	16,8	19,2	21,6	24
					0	100	120	160	200	240	280	320	360	400
P 18...-250/3T	2,5	1,85	2,2	4,2	34,7	32,9	32,6	31,6	30,1	28,0	24,7	20,6	15,9	10,7
P 18...-400/4T	4	3	3,0	5,8	47,1	45,4	45,2	44,3	42,6	40,0	36,0	30,6	24,6	17,8
P 18...-450/5T	4,5	3,37	3,9	6,9	59,2	57,6	57,4	56,4	54,5	51,6	46,7	40,1	33,3	25,3
P 18...-550/6T	5,5	4	4,6	8,4	71,4	69,7	69,6	68,2	65,7	62,2	56,3	48,0	39,4	29,4
P 18...-750/8T	7,5	5,5	6,2	11,2	96,1	94,2	94,1	92,4	89,1	84,5	77,0	66,1	54,2	41,1
P 18...-900/9T	10	7,5	6,9	12,8	108,5	106,9	107,0	105,3	101,7	96,8	88,6	75,9	62,6	47,8

PLUS LG

TYPE - 50 Hz	P2		P1	CURRENT	Q (m³/h - l/min)									
					3- 400V									
	HP	kW	kW	A	0	6	7,2	9,6	12	14,4	16,8	19,2	21,6	22,8
3-					0	6	7,2	9,6	12	14,4	16,8	19,2	21,6	22,8
					0	100	120	160	200	240	280	320	360	380
P 18LG-920/10T	10	7,5	7,7	14,0	120,4	116,8	118,3	116,6	112,6	104,4	96,3	85,8	67,8	60,1
P 18LG-1000/11T	10	7,5	8,3	13,6	132,4	128,9	130,0	128,0	123,0	115,0	103,9	93,0	72,6	63,4

PLUS V/L

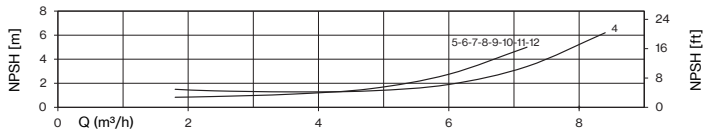
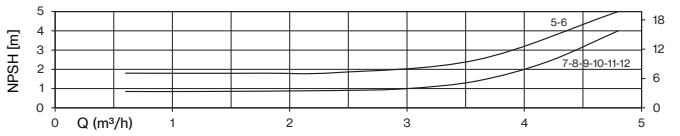
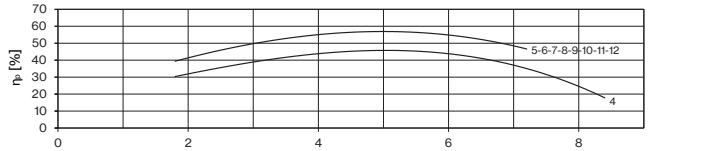
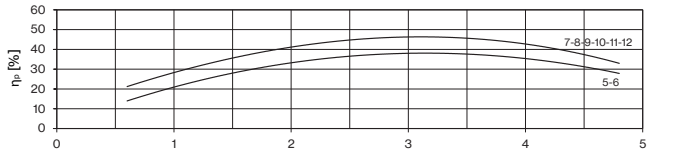
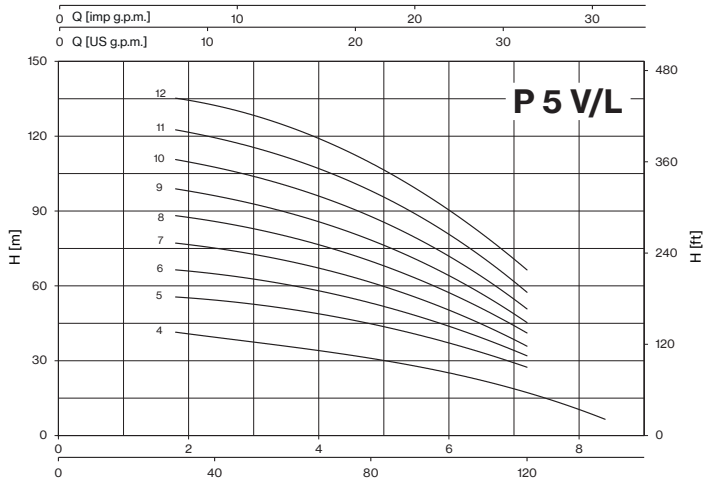
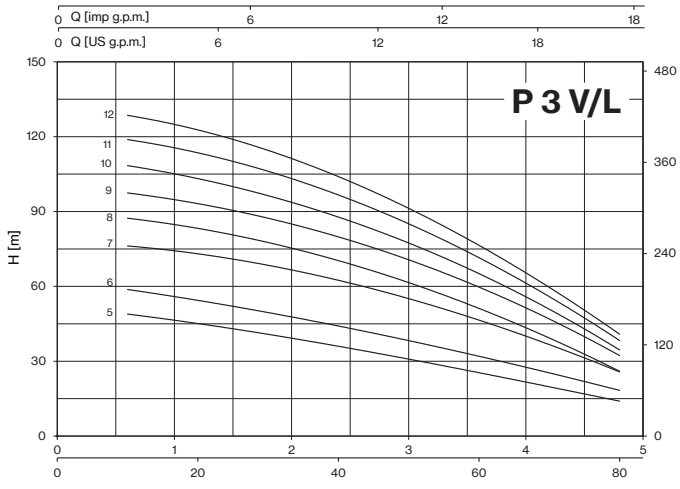

PLUS V/L-LG

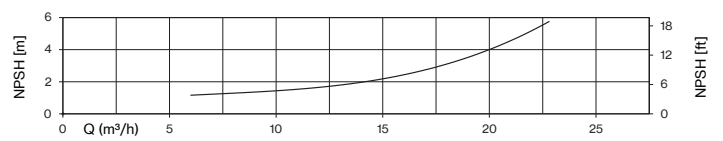
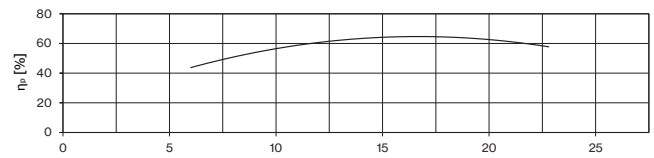
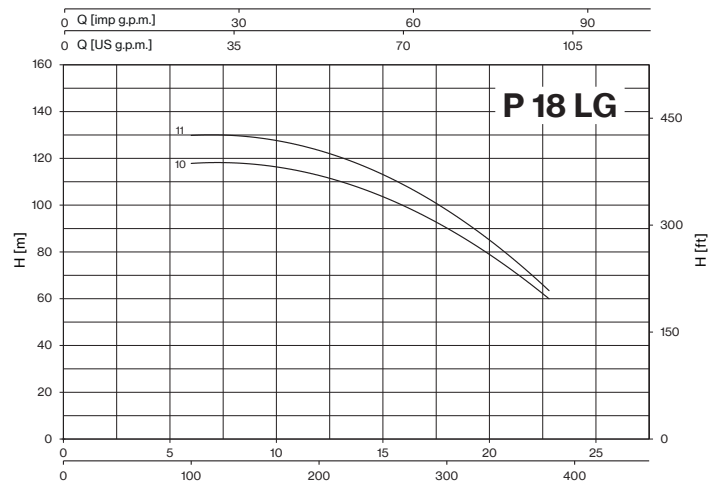
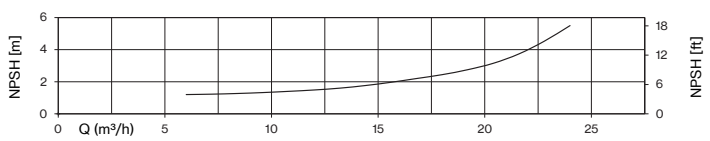
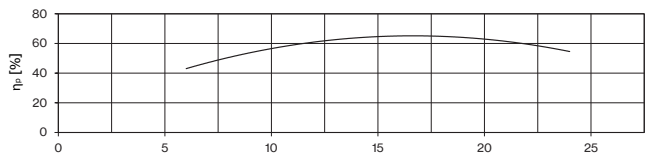
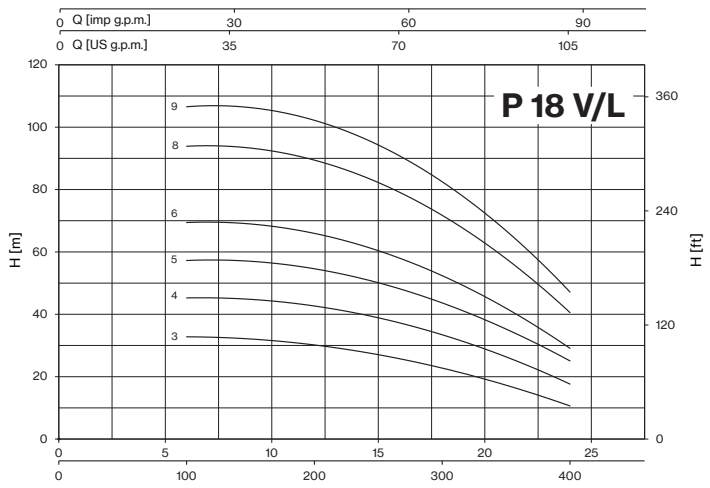
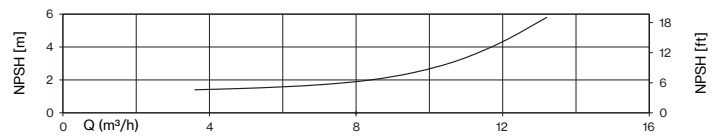
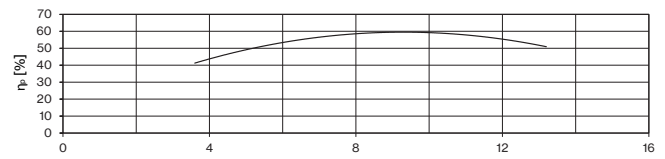
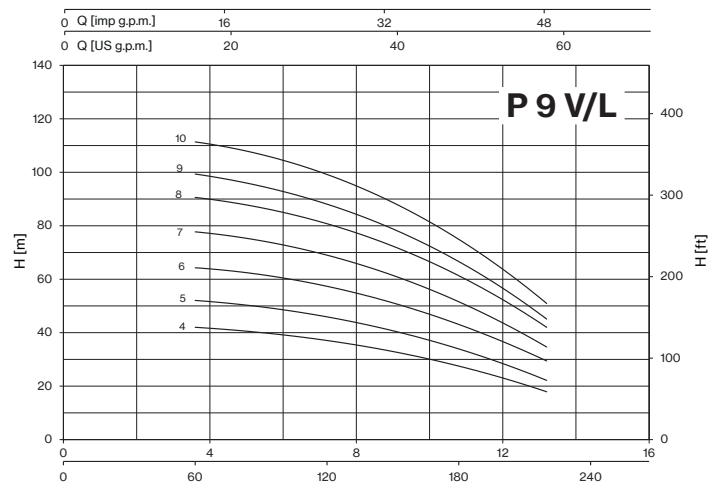
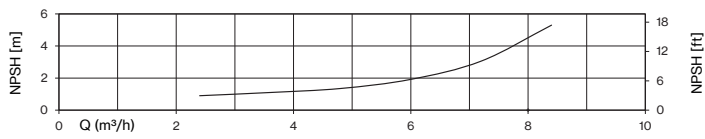
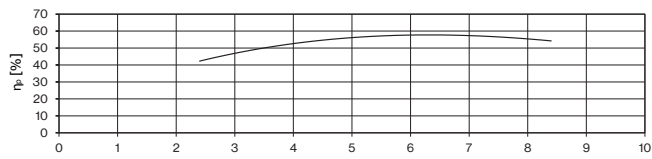
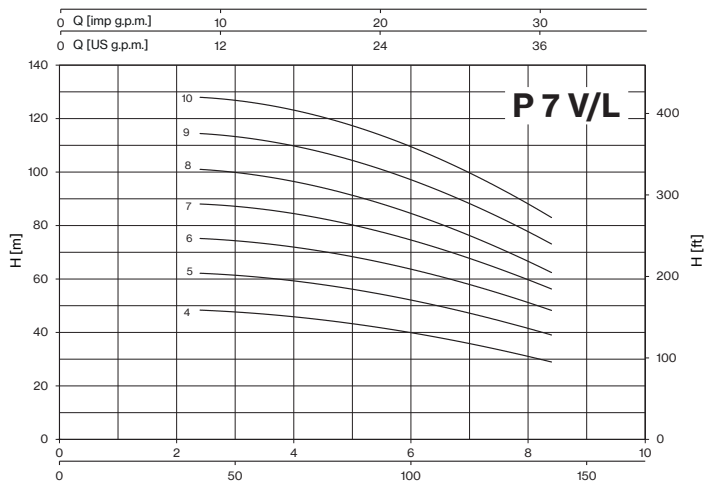

PLUS LG

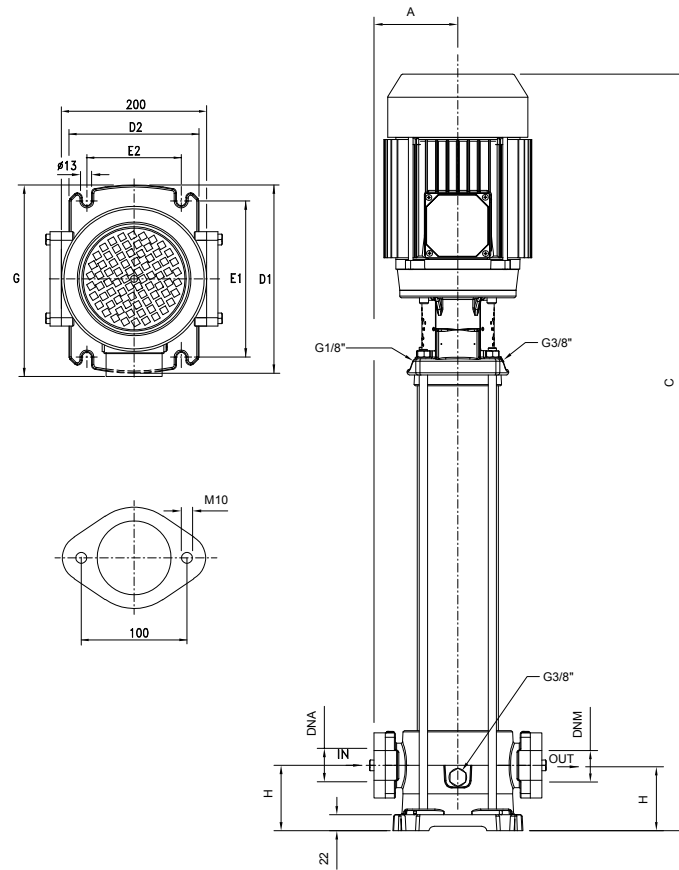

TYPE	DIMENSIONS (mm)										Kg	
	A	C	D1	D2	E1	E2	G	H	DNA	DNM		
-3												
P 18LG-920/10T	118	1019	260	180	215	130	307	90				68
P 18LG-1000/11T	118	1057	260	180	215	130	307	90	2" G	2" G		76

LOTS				
MODEL	TRUCK		CONTAINER	
	PALLET (cm)	N° pumps	PALLET (cm)	N° pumps
P 18LG-920/10T - 1000/11T	100×120×150	12	100×120×150	12

PLUS V-SV-L-SL-LG-SLG Serie-Mechanical seal and bearings

MECHANICAL SEAL	PUMP MODEL	SHAFT		STANDARD MATERIAL	OPTIONAL
					2
	P3-100/5, P3-120/6, P5-120/4, P5-150/5, P5-180/6, P7-180/4, P7-250/5, P7-300/6, P9-200/4, P9-250/5, P18-250/3, P18-400/4	14mm / S	Rotating face Stationary face Elastomer	Graphite Ceramic EPDM	SiC SiC EPDM
	P3-150/7, P3-180/8, P3-200/9, P3-250/10, P3-280/11, P3-300/12, P5-200/7, P5-250/8, P5-280/9, P5-300/10, P5-350/11, P5-380/12, P7-350/7, P7-400/8, P7-450/9, P7-550/10, P9-300/6, P9-400/7, P9-450/8, P9-500/9, P9-550/10	14mm	Rotating face Stationary face Elastomer	Graphite SiC EPDM	SiC SiC EPDM
	P18-450/5, P18-550/6, P18-750/8, P18-900/9, P18-920/10, P18-1000/11	14mm / L	Rotating face Stationary face Elastomer	Graphite SiC EPDM	SiC SiC EPDM
	P3-350/14, P3-380/16, P3-400/18, P3-450/20, P5-400/14, P5-450/16, P5-550/18, P5-600/20, P7-750/12, P7-800/14, P7-900/16, P7-950/18, P7-1000/20, P9-750/12, P9-800/14, P9-900/16, P9-950/18, P9-1000/20	14mm / Balanced seal	Rotating face Stationary face Elastomer	Tungsten carbide Graphite EPDM	- - -

BEARINGS	PUMP MODEL	TYPE	
	P3-100/5, P3-120/6, P5-120/4	6202-ZZ	6302-ZZ C3
	P3-150/7, P3-180/8, P3-200/9, P3-250/10, 3- P3-280/11, 3- P3-300/12, P5-150/5, P5-180/6, P5-200/7, P5-250/8, 3- P5-280/9, 3- P5-300/10, P7-180/4, P7-250/5, 3- P7-300/6, P9-200/4, P9-250/5, 3- P9-300/6, P18-250/3	6203-ZZ	6304-ZZ C3
	1- P3-280/11, 1- P3-300/12, 1- P5-280/9, 1- P5-300/10, P5-350/11, P5-380/12, 1- P7-300/6, P7-350/7, P7-400/8, 1- P9-300/6, P9-400/7, P18-400/4, P3-350/14, P3-380/16, P3-400/18, P5-400/14	6203-ZZ	6305-ZZ C3
	P7-450/9, P7-550/10, P9-450/8, P9-500/9, P9-550/10, P18-450/5, P18-550/6	6204-ZZ	6306-ZZ-C3
	P3-450/20, P5-450/16, P5-550/18, P5-600/20	6204-ZZ	3206-ZZ C3
	P7-750/12, P7-800/14, P7-900/16, P9-750/12, P9-800/14, P9-900/16, P18-750/8, P18-900/9, P18-920/10	6206-ZZ C3	3306-ZZ C3
	P7-950/18, P7-1000/20, P9-950/18, P9-1000/20, P18-1000/11	6206-ZZ C3	3308-ZZ C3

PLUS V/L/H + VSD

Vertical booster pump with variable speed drive

PLUS V



EPIC / EPIC-A

IPFC

PLUS L



EPIC / EPIC-A

IPFC

PLUS H



EPIC / EPIC-A

IPFC

DESCRIPTION

Vertical pump of PLUS series provided with variable speed drive EPIC, EPIC-A or IPFC. This booster pump assures a desired pressure regardless of changes on flow demand making it suitable for low or missing pressure in residential systems and industrial applications. It is required the installation of a membrane tank downstream the system.

FEATURES

- EPIC, EPIC-A or IPFC variable speed drive
- Three-phase vertical pump of PLUS series
- Pressure sensor wired to the vsd
- Cable with plug for EPIC vsd only

FUNCTIONING

If the pressure in the network drops the pump will start and gradually speeds up to provide with the set pressure. When the water demand decreases, the pressure will rise causing the pump speed to slow down and eventually to stop the pump if demand ceases. The pump will remain on standby waiting to start at the next water demand.

SELECTION

The next table shows the vertical PLUS pump models available for the assembly with EPIC, EPIC-A or IPFC. For pumps longer than 1.4m, IPFC is not assembled onto the motor fan cover but is supplied with a wall-mounting kit. Consult the catalog at the PLUS series for pump specifics and characteristic curves.

P3SL /A 100/5 T -304 3x400-50

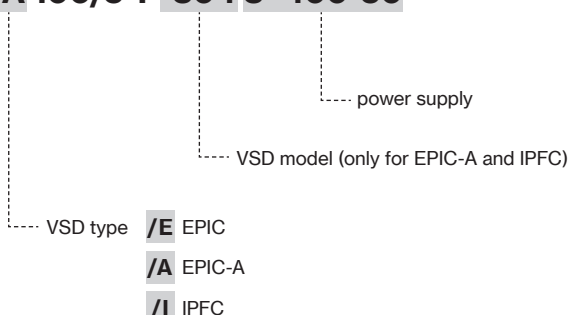

TYPE		3- PUMP						VSD TYPE			
		VERSION						Power supply			
		V	SV	L	SL/SLX	LG	SLG/SLGX	1-230V		3-400V	
P 3	100/5T	■	■	■	■	-	-	EPIC	IPFC 109	EPIC-A 304	IPFC 306
	120/6T	■	■	■	■	-	-				
	150/7T	■	■	■	■	-	-				
	180/8T	■	■	■	■	-	-				
	200/9T	■	■	■	■	-	-				
	250/10T	■	■	■	■	-	-		-	IPFC 114	EPIC-A 306
	280/11T	■	■	■	■	-	-				
	300/12T	■	■	■	■	-	-				
	350/14T	-	-	-	-	-	■				
	380/16T	-	-	-	-	-	■				
	400/18T	-	-	-	-	-	■				
450/20T	-	-	-	-	-	■					
P 5	120/4T	■	■	■	■	-	-	EPIC	IPFC 109	EPIC-A 304	IPFC 306
	150/5T	■	■	■	■	-	-				
	180/6T	■	■	■	■	-	-				
	200/7T	■	■	■	■	-	-				
	250/8T	■	■	■	■	-	-				
	280/9T	■	■	■	■	-	-				
	300/10T	■	■	■	■	-	-				
	350/11T	■	■	■	■	-	-				
	380/12T	■	■	■	■	-	-				
	400/14T	-	-	-	-	-	■				
	450/16T	-	-	-	-	-	■		-	-	IPFC 309
	550/18T	-	-	-	-	-	■				
600/20T	-	-	-	-	-	■	-	-	IPFC 311		
P 7	180/4T	■	■	■	■	-				-	EPIC
	250/5T	■	■	■	■	-	-				
	300/6T	■	■	■	■	-	-	-	IPFC 114	EPIC-A 306	
	350/7T	■	■	■	■	-	-				
	400/8T	■	■	■	■	-	-	-	-	EPIC-A 309	
	450/9T	■	■	■	■	-	-				
	550/10T	■	■	■	■	-	-	-	-	-	
	750/12T	-	-	-	-	-	■				
	800/14T	-	-	-	-	-	■				
	900/16T	-	-	-	-	-	■				
	950/18T	-	-	-	-	-	■				
1000/20T	-	-	-	-	-	■					
P 9	200/4T	■	■	■	■	-	-	EPIC	IPFC 109	EPIC-A 304	IPFC 306
	250/5T	■	■	■	■	-	-				
	300/6T	■	■	■	■	-	-		-	IPFC 114	EPIC-A 306
	400/7T	■	■	■	■	-	-				
	450/8T	■	■	■	■	-	-		-	-	EPIC-A 309
	500/9T	■	■	■	■	-	-				
	550/10T	■	-	■	-	-	-		-	-	-
	750/12T	-	-	-	-	-	■				
	800/14T	-	-	-	-	-	■				
	900/16T	-	-	-	-	-	■				
	950/18T	-	-	-	-	-	■				
	1000/20T	-	-	-	-	-	■				

PLUS+VSD

		3- PUMP							VSD TYPE		
TYPE		VERSION							Power supply		
		V	SV	L	SL/SLX	LG	HS	HX	1-230V	3~400V	
P 18	100/1T	-	-	-	-	-	-	■	IPFC 109	EPIC-A 304	IPFC 306
	200/2T	-	-	-	-	-	-	■			
	300/3T	-	-	-	-	-	-	■			
	250/3T	■	■	■	■	-	-	-	IPFC 114	EPIC-A 306	
	400/4T	-	-	-	-	-	-	■			
	450/5T	■	■	■	■	-	-	-	-	-	
	550/5T	-	-	-	-	-	-	■			
	550/6T	■	■	■	■	-	-	-			
	750/6T	-	-	-	-	-	-	■			IPFC 311
	750/7T	-	-	-	-	-	-	■			
	750/8T	■	■	■	■	-	-	-			
	1000/8T	-	-	-	-	-	-	■			IPFC 314
	1000/9T	-	-	-	-	-	-	■			
	900/9T	■	■	■	■	-	-	-			
	920/10T	-	-	-	-	■	-	-			
	1000/11T	-	-	-	-	■	-	-			IPFC 318
	1500/10T	-	-	-	-	-	-	■			
	1500/11T	-	-	-	-	-	-	■			
	1500/12T	-	-	-	-	-	-	■			
	1500/13T	-	-	-	-	-	-	■			IPFC 325
1500/14T	-	-	-	-	-	-	■				
2000/15T	-	-	-	-	-	-	■				
2000/16T	-	-	-	-	-	-	■				
2000/17T	-	-	-	-	-	-	■	IPFC 330			
P 22	200/1T	-	-	-	-	-	-	■	IPFC 109	-	IPFC 306
	300/2T	-	-	-	-	-	-	■			
	400/3T	-	-	-	-	-	-	■	IPFC 114		
	550/4T	-	-	-	-	-	-	■			
	750/5T	-	-	-	-	-	-	■	IPFC 309		
	1000/6T	-	-	-	-	-	-	■			
	1000/7T	-	-	-	-	-	-	■	IPFC 311		
	1500/8T	-	-	-	-	-	-	■			
	1500/9T	-	-	-	-	-	-	■	IPFC 314		
	1500/10T	-	-	-	-	-	-	■			
	2000/11T	-	-	-	-	-	-	■	IPFC 318		
	2000/12T	-	-	-	-	-	-	■			
	2000/13T	-	-	-	-	-	-	■	IPFC 325		
	2000/14T	-	-	-	-	-	-	■			

		3- PUMP							VSD TYPE	
TYPE		VERSION							Power supply	
		V	SV	L	SL/SLX	LG	HS	HX	1-230V	3-400V
P 35	300/1T	-	-	-	-	-	■	■	IPFC 114	IPFC 306
	550/2-2RT	-	-	-	-	-	■	■	-	IPFC 309
	550/2-1RT	-	-	-	-	-	■	■		IPFC 311
	750/2T	-	-	-	-	-	■	■		IPFC 314
	750/3-2RT	-	-	-	-	-	■	■		IPFC 318
	1000/3-1RT	-	-	-	-	-	■	■		IPFC 325
	1000/3T	-	-	-	-	-	■	■		
	1000/4-2RT	-	-	-	-	-	■	■		
	1500/4-1RT	-	-	-	-	-	■	■		
	1500/4T	-	-	-	-	-	■	■		
	1500/5-2RT	-	-	-	-	-	■	■		IPFC 330
	1500/5-1RT	-	-	-	-	-	■	■		
	2000/5T	-	-	-	-	-	■	■		
	2000/6-2RT	-	-	-	-	-	■	■		
	2000/6-1RT	-	-	-	-	-	■	■		-
	2000/6T	-	-	-	-	-	■	■		
2000/7-2RT	-	-	-	-	-	■	■			
2000/7-1RT	-	-	-	-	-	■	■			
P 50	400/1-1RT	-	-	-	-	-	■	■	IPFC 114	IPFC 306
	550/1T	-	-	-	-	-	■	■	-	IPFC 309
	750/2-2RT	-	-	-	-	-	■	■		IPFC 311
	1000/2T	-	-	-	-	-	■	■		IPFC 318
	1500/3-2RT	-	-	-	-	-	■	■		IPFC 325
	1500/3T	-	-	-	-	-	■	■		IPFC 330
	2000/4-2RT	-	-	-	-	-	■	■		-
	2000/4T	-	-	-	-	-	■	■		
	2500/5-2RT	-	-	-	-	-	■	■		
	2500/5T	-	-	-	-	-	■	■		
	3000/6-2RT	-	-	-	-	-	■	■		
	3000/6T	-	-	-	-	-	■	■		
	4000/7-2RT	-	-	-	-	-	■	■		
P 75	550/1-1RT	-	-	-	-	-	■	■	-	IPFC 309
	750/1T	-	-	-	-	-	■	■		IPFC 311
	1000/2-2RT	-	-	-	-	-	■	■		IPFC 318
	1500/2-1RT	-	-	-	-	-	■	■		IPFC 325
	1500/2T	-	-	-	-	-	■	■		IPFC 330
	2000/3-2RT	-	-	-	-	-	■	■		-
	2000/3-1RT	-	-	-	-	-	■	■		
	2500/3T	-	-	-	-	-	■	■		
	2500/4-2RT	-	-	-	-	-	■	■		
	3000/4-1RT	-	-	-	-	-	■	■		
	3000/4T	-	-	-	-	-	■	■		
4000/5-2RT	-	-	-	-	-	■	■			
P 90	750/1-1RT	-	-	-	-	-	■	■	-	IPFC 311
	1000/1T	-	-	-	-	-	■	■		IPFC 318
	1500/2-2RT	-	-	-	-	-	■	■		IPFC 325
	2000/2T	-	-	-	-	-	■	■		IPFC 330